



## Cinzia



### Cinzia

"Cinzia" is a series of light fitting for compact fluorescent lamps combined with halogen or metal halide R111 adjustable lamps. Installations: wall and ceiling mounted or suspended.

#### Materials

Body in white zinc coated steel.  
Frame in anodized extruded aluminium.  
Opal PMMA diffuser.

#### Wiring

Electronic ballast/  
transformer 220-240V  
50/60Hz; rigid cable  
H05V2-U section 0,75  
mm<sup>2</sup> (CEI 20-20); socket  
terminal 3P+T (section  
max 2,5 mm<sup>2</sup>).

Other possibilities:  
dimmable ballast.  
In accordance with stan-  
dard IEC 598, CEI EN  
60598-1 (CEI 34-21).



# Cinzia

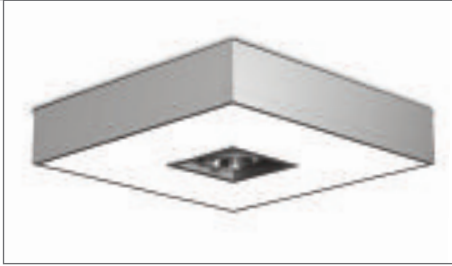

Code	Lamps Watt	
E014D4J1AAO	4x36	FSD 2G11
	1x50	QR111 G53
E014D4J1HAO	4x36	FSD 2G11
	1x35	CDMR111 GX8.5

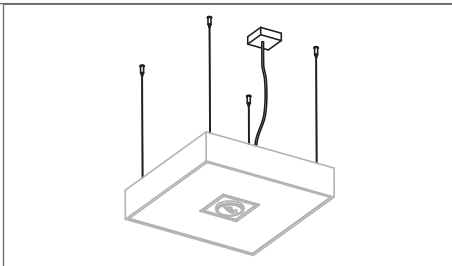

Code	L mm
A015K2000KK	2000

Suspension kit: 4 steel wires, transparent power cable 5x0,75 mmq, grey ceiling cover and terminal block.



Light fitting in extruded aluminium with opal diffuser for compact fluorescent lamps and metal halide CDMR111 or halogen QR111 lamps. Suspension or ceiling fixing.

Available on request painted in white colour.

Colours

A 

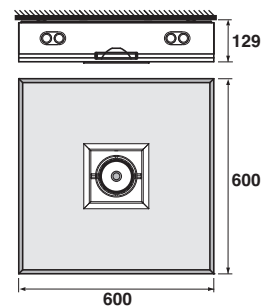

# Cinzia

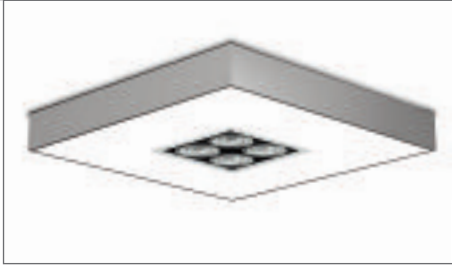

Code	Lamps Watt	
E014D4J4AAO	4x55	FSD 2G11
	4x50	QR111 G53
E014D4J4HAO	4x55	FSD 2G11
	4x35	CDMR111 GX8.5

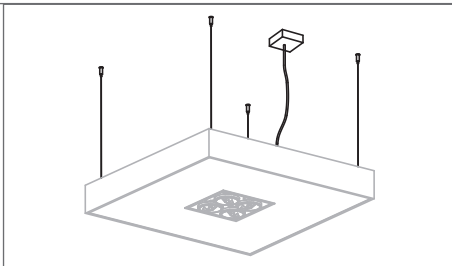

Code	L mm
A015K2000KK	2000

Suspension kit: 4 steel wires, transparent power cable 5x0,75 mmq, grey ceiling cover and terminal block.



Light fitting in extruded aluminium with opal diffuser for compact fluorescent lamps and metal halide CDMR111 or halogen QR111 lamps. Suspension or ceiling fixing.

Available on request painted in white colour.

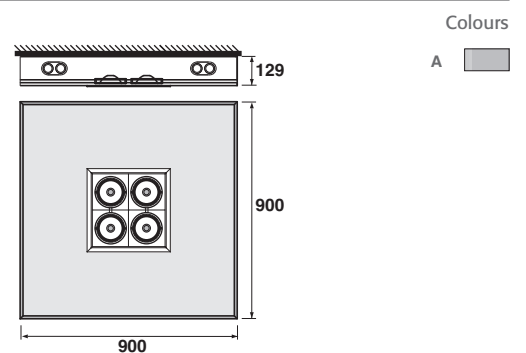



# Cinzia



Codice	Lampade Watt	
E014D1V1AAO	1x60	FSCH 2Gx13
	1x50	QR111 G53
E014D1V1HAO	1x60	FSCH 2Gx13
	1x35	CDMR111 GX8.5

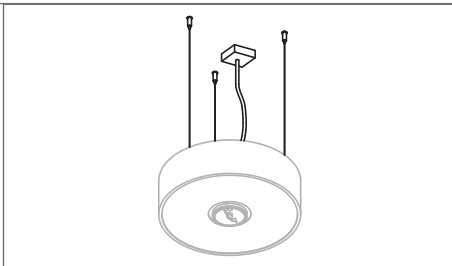

Code	L mm
A014K2000KK	2000

Suspension kit: 3 steel wires, transparent power cable 5x0,75 mmq, grey ceiling cover and terminal block.



Light fitting in extruded aluminium with opal diffuser for T5 circular fluorescent lamps and metal halide CDMR111 or halogen QR111 lamps. Suspension or ceiling fixing.

Available on request painted in white colour.

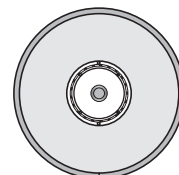
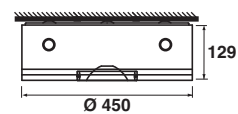

Colours

A 



Code	Lamps Watt
G015D1221A0	12x21

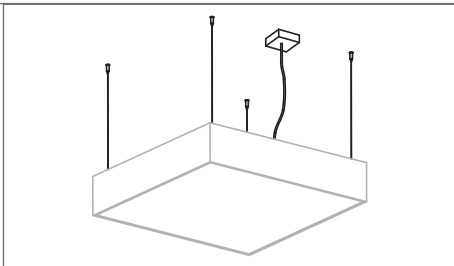

Code	L mm
A015K2000KK	2000

Suspension kit: 4 steel wires, transparent power cable 5x0,75 mmq, grey ceiling cover and terminal block.



Light fitting in extruded aluminium with opal diffuser for T5 RGB fluorescent lamps with DALI power supply. Suspension or ceiling fixing.

Available on request painted in white colour.

**TO COMPLETE WITH LIGHT MANAGEMENT SYSTEM: SEE ON PAGE 456**

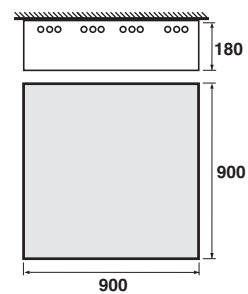

Colours  
A

