

## ECO

ECO is an elegant and compact projector for track installation, ideal for spaces where the presence of the luminaire should be highlighted, making it an integral part of the furniture, with particular emphasis on the aesthetic solutions adopted.

Its fully adjustable frame, along with the possibility of using different light sources, ensure maximum versatility of use, providing flexible and dynamic characteristics that can meet both aesthetic and lighting needs, creating solutions that optimally respond to various styles and architectures with high quality.

### Technical specifications

ECO is fully made of die-cast aluminium with UV-stabilised epoxy polyester coat finish. It is fully adjustable and can be installed in different fields of application, thanks to the use of different types of light sources, such as LED and discharge lamps.

The luminaire is provided in a single size, with three different finishes – white, grey and black. Using its special base, it can also be installed on the ceiling or in false ceilings.

### Structural features

Installation: track, ceiling, false ceiling  
Luminaire housing: die-cast aluminium  
Louver: tempered glass  
Reflector: super-pure oxidised and polished aluminium  
Light sources: discharge lamps and LED lamps  
Standard finishing: white, grey, black  
Protection class: IP40  
Insulation class: I   
Power supply: 230V-50Hz

### Optical components and light sources

Eco projectors have been designed for use with 20W, 35W discharge lamps and 19W LEDs

#### DISCHARGE LAMPS









	MT (CDM-T) - PGJ5	20W
	MT (CDM-T) - PGJ5	35W

#### LED

	9 LED - 19W	500 mA
---	-------------	--------



Adjustable projector for discharge lamps.  
It comes complete with electronic ballast

CODE	DESCRIPTION	
5551	MT(CDM-T) - 20W - PGJ5 230V - 50Hz <b>Electronic ballast</b> Colour: 01 - 02 - 18 IP 40 Kg 1.80 With 2 x 15° reflector	   
5550	MT(CDM-T) - 35W - PGJ5 230V - 50Hz <b>Electronic ballast</b> Colour: 01 - 02 - 18 IP 40 Kg 1.80 With 2 x 15° reflector	   

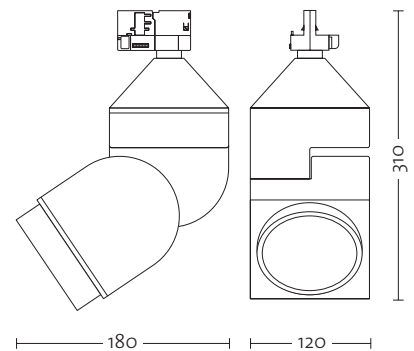

Dimensions in mm

#### ACCESSORIES

- 658 Adapter kit for ceiling installation (available colours: 01 - 02 - 18)
- 659 Adapter kit for false ceiling installation (available colours: 01 - 02 - 18)

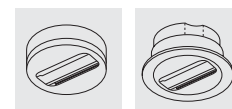

658

659

- 01 white
- 02 black
- 18 grey

#### NOTES

Adjustable projector for LED light sources.  
It comes complete with electronic ballast

ECO

DESIGN - QUATTROBI TECHNICAL DEPARTMENT

CODE	DESCRIPTION
5552	White LED 6300K 9 LEDs - 19W - 500mA 230V - 50Hz <b>Electronic ballast</b> Colour: 01 - 02 - 18 IP 40 Kg 1.60

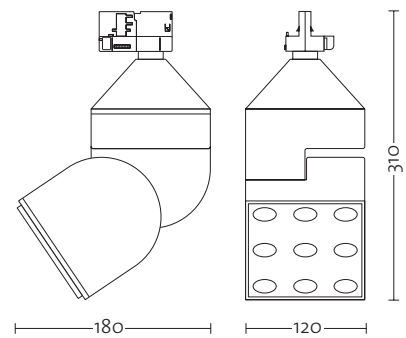

Dimensions in mm

**ACCESSORIES**

- 658 Adapter kit for ceiling installation (available colours: 01 - 02 - 18)
- 659 Adapter kit for false ceiling installation (available colours: 01 - 02 - 18)

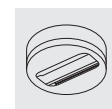

658

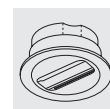

659

- 01 white
- 02 black
- 18 grey

**NOTES**