

M100 CASSETTE

- PENDANT OR SURFACE MOUNTED LUMINAIRE
- **m-SYSTEM**: CUSTOMER SPECIFIES LENGTH OF MODULE
- DIRECT AND DIRECT / INDIRECT
- MICROPRISMATIC MULTILAYER DIFFUSER – HIGHLY ADVANCED ANTI-GLARE CHARACTERISTICS (UGR<19)
- DIMMABLE VERSIONS ON REQUEST
- SQUARE-EDGED EXTRUDED ALUMINIUM
- END CAPS OF DIE-CAST ALUMINIUM
- SILVER FINISH

M100 MICROPRISMS DIRECT

M100 MICROPRISMS DIRECT/INDIRECT



M100 MICROPRISMS DIRECT

		SILVER	L	B	H	P	W	DATA
1 x 28W	single length	SX 704 013 128	1196	100	100	900	6.0kg	3034
1 x 35W	single length	SX 704 013 135	1496	100	100	1200	7.5kg	3034
2 x 1 x 28W	double length	SX 704 023 128	2376	100	100	1040	11.6kg	3034
2 x 1 x 35W	double length	SX 704 023 135	2976	100	100	1340	14.2kg	3034
1 x 35 / 28 / 21W	m-System	SX 70053-972-3	var.	100	100	var.	4.9kg/m	3034

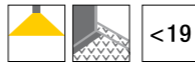

M100 MICROPRISMS DIRECT – STAGGERED LAMPS

		SILVER	L	B	H	P	W	DATA
1 x 35 / 28 / 21W	m-System	SX 72153-972-3	var.	100	100	var.	4.9kg/m	3037



M100 MICROPRISMS DIRECT/INDIRECT

		SILVER	L	B	H	P	W	DATA
1 x 28W	single length	SX 707 013 128	1196	100	100	900	6.0kg	3052
1 x 35W	single length	SX 707 013 135	1496	100	100	1200	7.5kg	3052
2 x 1 x 28W	double length	SX 707 023 128	2376	100	100	1040	11.6kg	3052
2 x 1 x 35W	double length	SX 707 023 135	2976	100	100	1340	14.2kg	3052
1 x 35 / 28 / 21W	m-System	SX 70153-972-3	var.	100	100	var.	4.9kg/m	3052

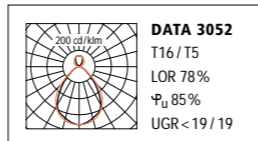
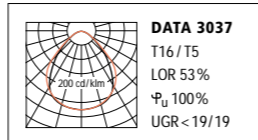
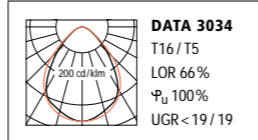
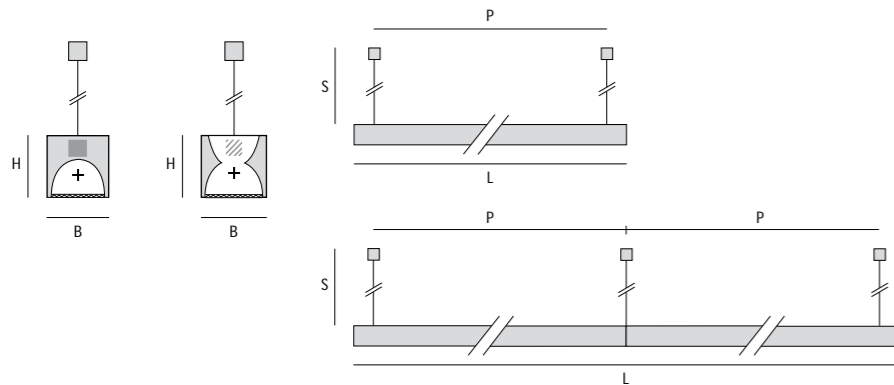
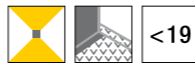

L: Length · B: Width · H: Height · P: Distance between suspension points · W: Weight · S: Suspension, 1500 mm suspension can be cut on site
Dimmable versions for M100 DIRECT: .../04 = 1-10V · .../05 = DSI · .../06 = DALI
For **m-system** end caps and suspensions have to be ordered separately – see page 045





M100 CASSETTE ACCESSORIES FOR -SYSTEM

END CAP

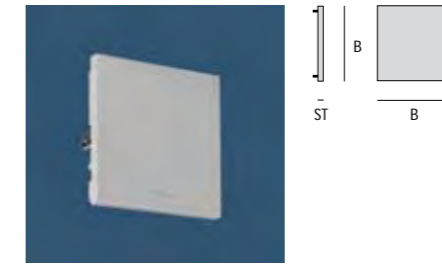

SILVER	B	ST
SX 99-443-3	100	8

RECESSED DOWNLIGHT INFILL



SILVER	
SX 99-714-3	QPAR 16 lamp for mains voltage

T MITRE

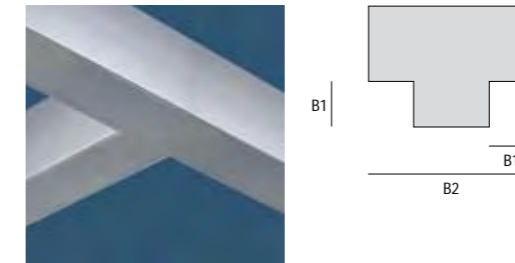

SILVER	B1	B2
SX 98-175-3	60	220

L MITRE

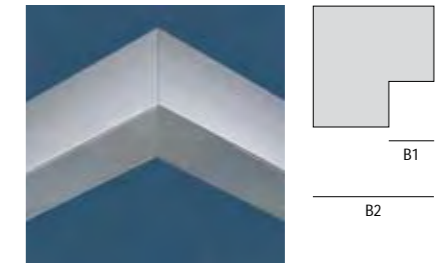

SILVER		B1	B2
SX 98-176-3	30°-180°	60	220

MITRED END CUT

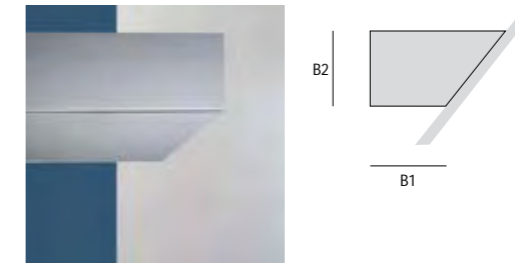

SILVER		B1	B2
SX 98-174-3	30°-180°	mind. 60	100

X MITRE

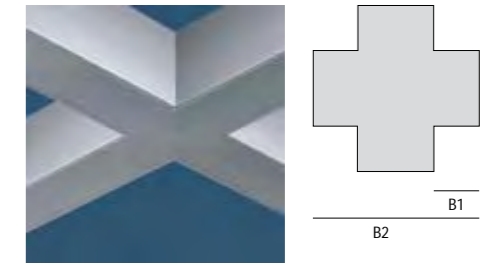

SILVER		B1	B2
SX 98-177-3		60	220

PENDANT



SILVER		Ø	H*
SX 99-820-3	pendant rod without feed	10mm	600
SX 99-821-3		10mm	1200
SX 99-833-3	pendant rod with feed (3 x 1.5 ²)	10mm	600
SX 99-834-3		10mm	1200
SX 99-822-3	pendant rod without feed	13mm	600
SX 99-823-3		13mm	1200
SX 99-835-3	pendant rod with feed (5 x 1.5 ²)	13mm	600
SX 99-836-3		13mm	1200

WIRE SUSPENSION

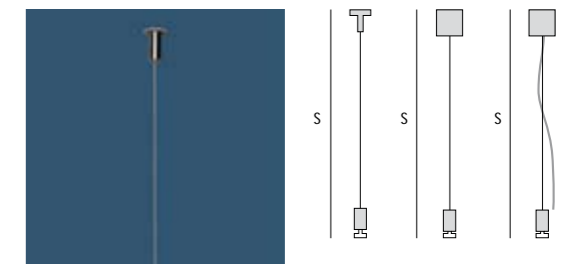

SILVER		S*
SX 99-830-3	with ceiling mounting	1500
SX 99-831-3		3000
SX 99-828-3	with canopy	1500
SX 99-829-3		3000
SX 99-824-3	with 3 core supply cable (3 x 0.75 ²)	1500
SX 99-825-3		3000
SX 99-826-3	with 5 core supply cable (5 x 1.5 ²)	1500
SX 99-827-3		3000

B: Width · ST: Thickness · Ø: Diameter · H: Pendant rod length · S: Wire suspension length
* can be cut on site