

# M150 MICROPRISMS

- RECESSED LUMINAIRE
- **m**-SYSTEM: CUSTOMER SPECIFIES LENGTH OF MODULE
- MICROPRISMATIC MULTILAYER DIFFUSER – HIGHLY ADVANCED ANTI-GLARE CHARACTERISTICS (UGR<19)
-  SUITABLE FOR VDU WORKSPACES (L<1000 CD/M² FOR GAMMA≥65° RADIALY AROUND)
- EXTRUDED ALUMINIUM PROFILE

## M150 MICROPRISMS WITH TRIM

## M150 MICROPRISMS TRIMLESS

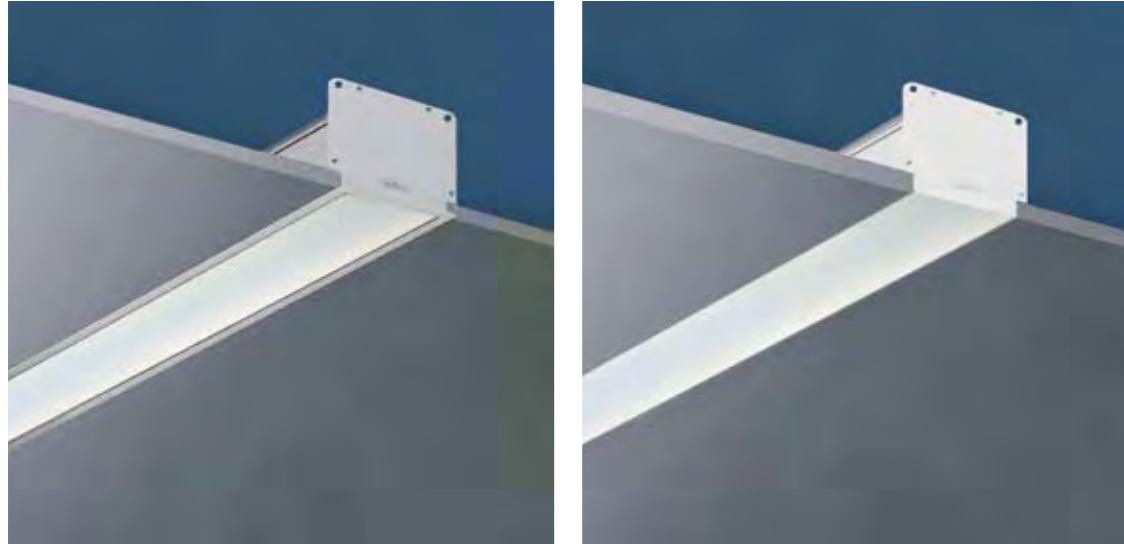

## M150 MICROPRISMS WITH TRIM

	SILVER	L	B	H	C	W	DATA
1 x 35 / 28 / 21W	<b>SX 66353-972-3</b>	var.	175	123	L x 155	6.8kg/m	2305
2 x 35 / 28 / 21W	<b>SX 66354-972-3</b>	var.	175	123	L x 155	6.8kg/m	2309

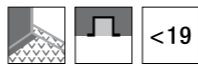

## M150 MICROPRISMS TRIMLESS

	WHITE	L	B	H	C	W	DATA
1 x 35 / 28 / 21W	<b>SX 66553-972-1</b>	var.	204	140	L x 150	6.4kg/m	2305
2 x 35 / 28 / 21W	<b>SX 66554-972-1</b>	var.	204	140	L x 150	7.0kg/m	2309

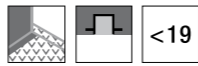

## M150 MICROPRISMS WITH TRIM, STAGGERED LAMPS

	SILVER	L	B	H	C	W	DATA
1 x 35 / 28 / 21W	<b>SX 66453-972-3</b>	var.	175	123	L x 155	6.9kg/m	2311

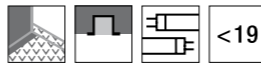

## M150 MICROPRISMS TRIMLESS, STAGGERED LAMPS

	WHITE	L	B	H	C	W	DATA
1 x 35 / 28 / 21W	<b>SX 66653-972-1</b>	var.	204	140	L x 150	6.9kg/m	2311

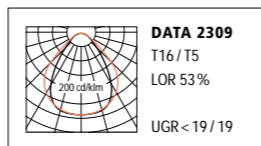
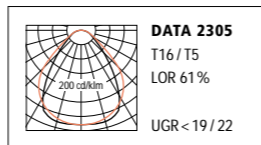
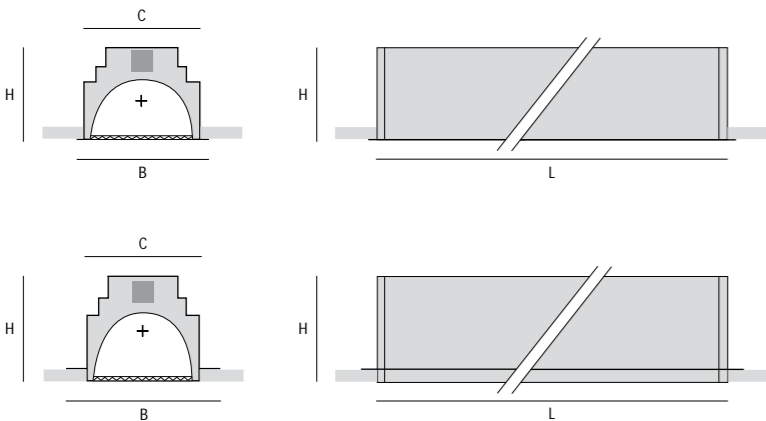
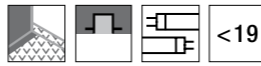

L: Length · B: Width · H: Height · C: Ceiling cut-out · W: Weight  
 Dimmable versions: .../04 = 1-10V · .../05 = DSI · .../06 = DALI · .../08 = CLT · Additional photometrics on request  
 For **m**-system end plates and suspensions have to be ordered separately – see page 120



## M150 ACCESSORIES FOR -SYSTEM

### END FLANGE



SILVER	B
SX 99-531-3	14mm

### END PLATE



WHITE	SILVER	ST
SX 98-104-1	SX 99-840-3	2mm

### PROFILE SNAP HANGER



SX 99-259-0	set of 6
-------------	----------

### ROTATING CROSS BAR



SX 99-529-0	set of 2
-------------	----------

B: Width · ST: Thickness