

M60x90 CASSETTE

- PENDANT OR SURFACE MOUNTED LUMINAIRE
- **m-SYSTEM**: CUSTOMER SPECIFIES LENGTH OF MODULE
- DIRECT
- MICROPRISMATIC MULTILAYER DIFFUSER – HIGHLY ADVANCED ANTI-GLARE CHARACTERISTICS (UGR<19)
- **S** SATIN FINISH PARABOLIC LOUVRE – SUITABLE FOR VDU WORKSPACES (L<1000 CD/M² FOR GAMMA=65°)
- DIMMABLE VERSIONS ON REQUEST
- SQUARE-EDGED EXTRUDED ALUMINIUM
- END CAPS OF DIE-CAST ALUMINIUM
- SILVER FINISH

M60x90 MICROPRISMS

M60x90 PARABOLIC

M60 WALL see page 070



M60x90 MICROPRISMS

		SILVER	L	B	H	P	W	DATA
1 x 28W	single length	SX 751 013 128	1192	60	90	900	3.6kg	4806
1 x 35W	single length	SX 751 013 135	1492	60	90	1200	4.5kg	4806
2 x 1 x 28W	double length	SX 751 023 128	2372	60	90	1040	6.0kg	4806
2 x 1 x 35W	double length	SX 751 023 135	2972	60	90	1440	8.6kg	4806
1 x 35 / 28 / 21W	m-System	SX 77153-972-3	var.	60	90	var.	2.9kg/m	4806

M60x90 MICROPRISMS – STAGGERED LAMPS

		SILVER	L	B	H	P	W	DATA
1 x 35 / 28 / 21W	m-System	SX 74853-972-3	var.	60	90	var.	2.9kg/m	4805

M60x90 PARABOLIC

		SILVER	L	B	H	P	W	DATA
1 x 28W	single length	SX 752 013 128	1192	60	90	900	3.6kg	4810
1 x 35W	single length	SX 752 013 135	1492	60	90	1200	4.5kg	4810
2 x 1 x 28W	double length	SX 752 023 128	2372	60	90	1040	6.0kg	4810
2 x 1 x 35W	double length	SX 752 023 135	2972	60	90	1440	8.6kg	4810
1 x 35 / 28 / 21W	m-System	SX 77153-973-3	var.	60	90	var.	2.9kg/m	4810

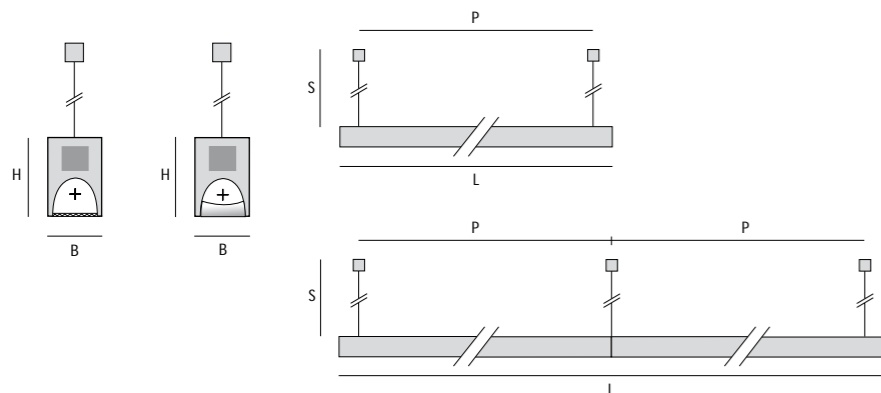

L: Length · B: Width · H: Height · P: Distance between suspension points · W: Weight · S: Suspension = 1500mm can be cut on site

Dimmable versions: .../04 = 1-10V · .../05 = DSI · .../06 = DALI

For **m-system** end caps and suspensions have to be ordered separately – see page 036

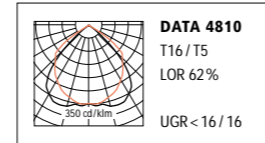
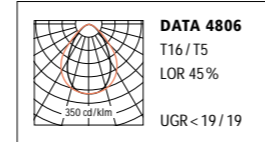
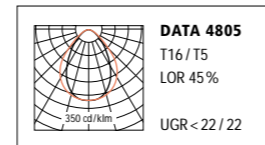

M60x90 CASSETTE

- PENDANT OR SURFACE MOUNTED LUMINAIRE
- **m-SYSTEM**: CUSTOMER SPECIFIES LENGTH OF MODULE
- DIRECT
- SATIN ACRYLIC DIFFUSER WITH STANDARD LAMP POSITION FOR HIGH LUMEN OUTPUT
- OPAL DIFFUSER WITH STAGGERED LAMP POSITION FOR CONTINUOUS RUNS OFFER EXCELLENT UNIFORMITY
- DIMMABLE VERSIONS ON REQUEST
- SQUARE-EDGED EXTRUDED ALUMINIUM
- END CAPS OF DIE-CAST ALUMINIUM
- SILVER FINISH

M60x90 SATINÉ – HIGH EFFICIENCY

M60x90 OPAL – EXCELLENT UNIFORMITY



M60x90 SATINÉ – HIGH EFFICIENCY

		SILVER	L	B	H	P	W	DATA
1 x 28W	single length	SX 771 013 128	1192	60	90	900	3.6kg	4811
1 x 35W	single length	SX 771 013 135	1492	60	90	1200	4.5kg	4811
2 x 1 x 28W	double length	SX 771 023 128	2372	60	90	1040	6.0kg	4811
2 x 1 x 35W	double length	SX 771 023 135	2972	60	90	1440	8.6kg	4811
1 x 35 / 28 / 21W	m-System	SX 77153-976-3	var.	60	90	var.	2.9kg/m	4811

M60x90 OPAL – EXCELLENT UNIFORMITY

		SILVER	L	B	H	P	W	DATA
1 x 35 / 28 / 21W	m-System	SX 74853-976-3	var.	60	90	var.	2.9kg/m	4807

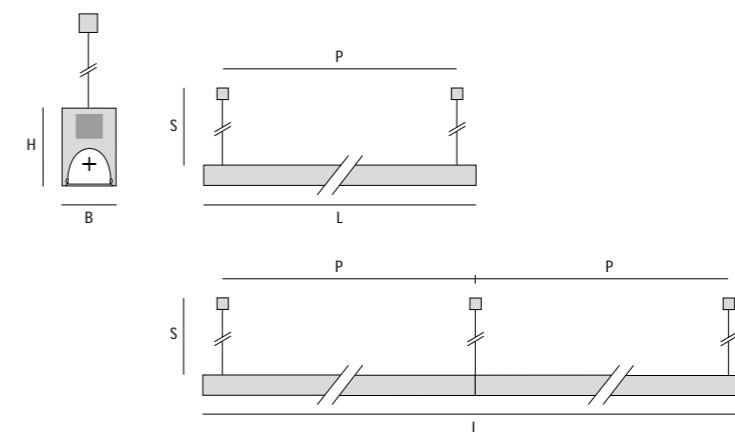

L: Length · B: Width · H: Height · P: Distance between suspension points · W: Weight · S: Suspension, 1500mm suspension can be cut on site

Dimmable versions: .../04 = 1-10V · .../05 = DSI · .../06 = DALI

For **m-system** end caps and suspensions have to be ordered separately – see page 036

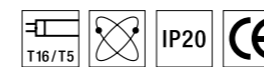
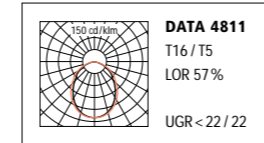

M60x90 CASSETTE ACCESSORIES FOR m-SYSTEM

END CAP

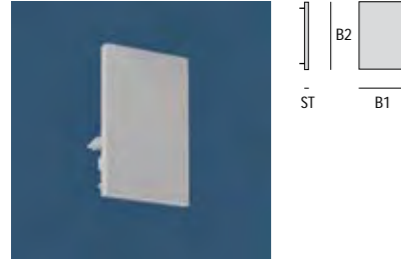

SILVER	B1	B2	ST
SX 98-100-3	60	90	6

RECESSED DOWNLIGHT INFILL M60



SILVER	
SX 99-715-3	QPAR 16 lamp for mains voltage

T MITRE

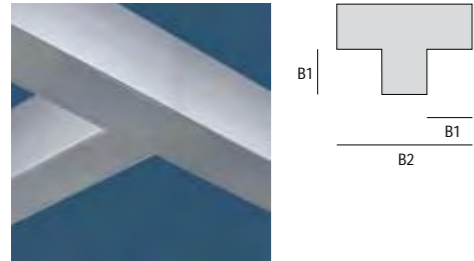

SILVER	B1	B2
SX 98-171-3	60	180

L MITRE

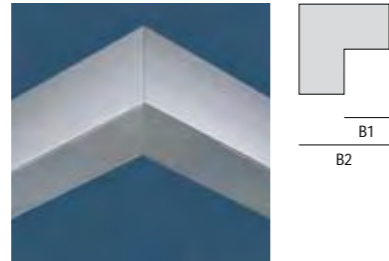

SILVER	B1	B2
SX 98-172-3	30°-180°	60 120

MITRED END CUT

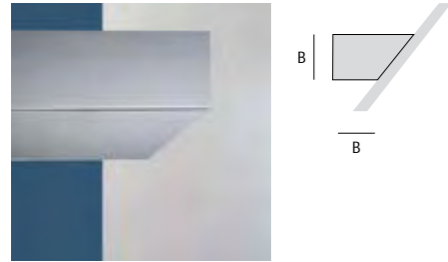

SILVER	B
SX 98-170-3	30°-180° 60

X MITRE

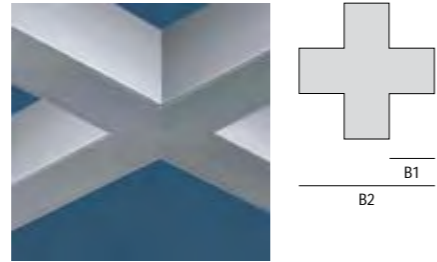

SILVER	B1	B2
SX 98-173-3	60	180

PENDANT ROD



SILVER		Ø	H*
SX 99-820-3	pendant rod without feed	10mm	600
SX 99-821-3		10mm	1200
SX 99-833-3	pendant rod with feed (3 x 1.5 ²)	10mm	600
SX 99-834-3		10mm	1200
SX 99-822-3	pendant rod without feed	13mm	600
SX 99-823-3		13mm	1200
SX 99-835-3	pendant rod with feed (5 x 1.5 ²)	13mm	600
SX 99-836-3		13mm	1200

WIRE SUSPENSION

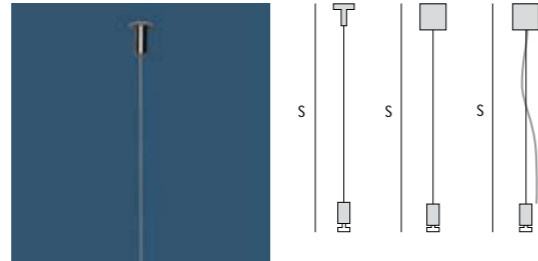

SILVER		S*
SX 99-830-3	with ceiling mounting	1500
SX 99-831-3		3000
SX 99-828-3	with canopy	1500
SX 99-829-3		3000
SX 99-824-3	with 3 core supply cable (3 x 0.75 ²)	1500
SX 99-825-3		3000
SX 99-826-3	with 5 core supply cable (5 x 1.5 ²)	1500
SX 99-827-3		3000

B: Width · ST: Thickness · Ø: Diameter · H: Pendant rod length · S: Wire suspension length
* can be cut on site



M60x90 CASSETTE ACCESSORIES FOR m-SYSTEM

END CAP

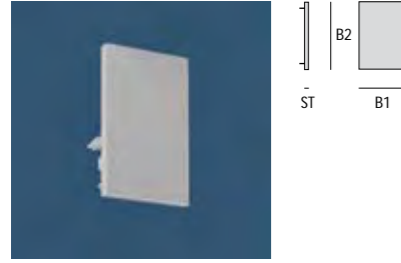

SILVER	B1	B2	ST
SX 98-100-3	60	90	6

RECESSED DOWNLIGHT INFILL M60



SILVER	
SX 99-715-3	QPAR 16 lamp for mains voltage

T MITRE

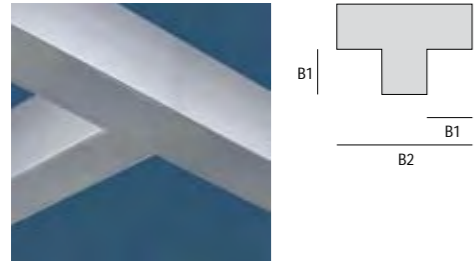

SILVER	B1	B2
SX 98-171-3	60	180

L MITRE

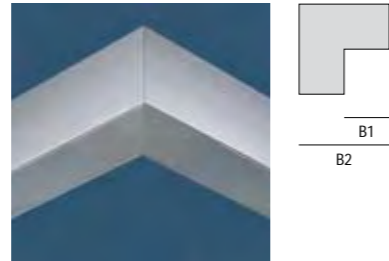

SILVER	B1	B2
SX 98-172-3	30°-180°	60 120

MITRED END CUT

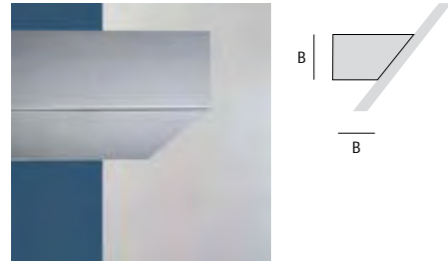

SILVER	B
SX 98-170-3	30°-180° 60

X MITRE

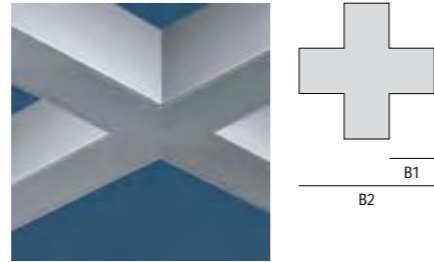

SILVER	B1	B2
SX 98-173-3	60	180

PENDANT ROD



SILVER		Ø	H*
SX 99-820-3	pendant rod without feed	10mm	600
SX 99-821-3		10mm	1200
SX 99-833-3	pendant rod with feed (3 x 1.5 ²)	10mm	600
SX 99-834-3		10mm	1200
SX 99-822-3	pendant rod without feed	13mm	600
SX 99-823-3		13mm	1200
SX 99-835-3	pendant rod with feed (5 x 1.5 ²)	13mm	600
SX 99-836-3		13mm	1200

WIRE SUSPENSION

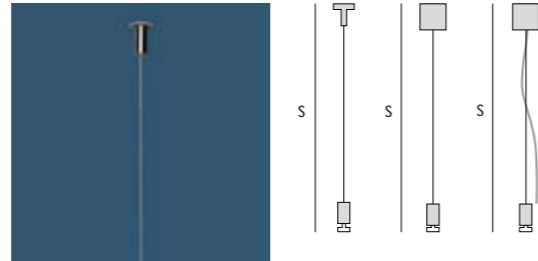

SILVER		S*
SX 99-830-3	with ceiling mounting	1500
SX 99-831-3		3000
SX 99-828-3	with canopy	1500
SX 99-829-3		3000
SX 99-824-3	with 3 core supply cable (3 x 0.75 ²)	1500
SX 99-825-3		3000
SX 99-826-3	with 5 core supply cable (5 x 1.5 ²)	1500
SX 99-827-3		3000

B: Width · ST: Thickness · Ø: Diameter · H: Pendant rod length · S: Wire suspension length
* can be cut on site

