

SYSTEM 60

- PENDANT LUMINAIRE
- -SYSTEM: CUSTOMER SPECIFIES LENGTH OF MODULE
- DIRECT
- SATIN DIFFUSER
- CIRCULAR EXTRUDED ALUMINIUM BODY
- END CAPS OF DIE-CAST ALUMINIUM
- SILVER FINISH

SYSTEM 60 SATINÉ



SYSTEM 60 SATINÉ

	SILVER	Ø	L	P	W	DATA
1 x 35 / 28 / 21 W	-System	SX 06753-976-3	60	var.	var.	2.0kg/m 1017

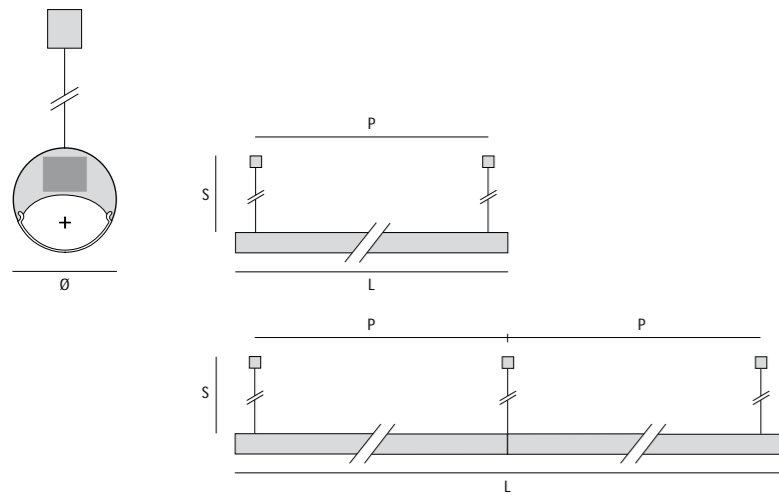

Ø: Diameter · L: Length · P: Distance between suspension points · W: Weight
 Dimmable versions: .../04 = 1-10V · .../05 = DSI · .../06 = DALI · Photometrics on request
 For -system end caps and suspensions have to be ordered separately – see page 059



SYSTEM 60 SYSTEM PARTS

SHORT CORNER

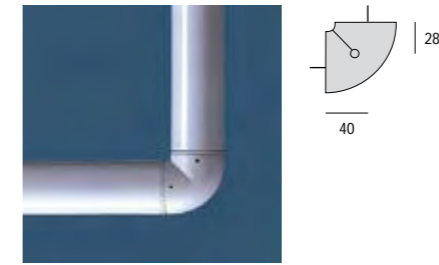

SILVER
SX 99-345-3

VARIABLE CORNER

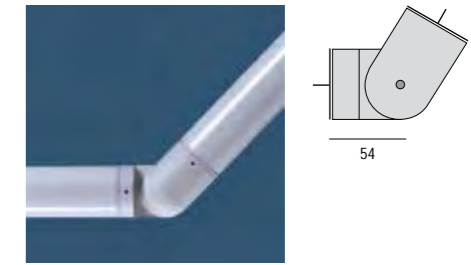

SILVER
SX 99-346-3 adjustable 90–270°

CEILING MOUNTING

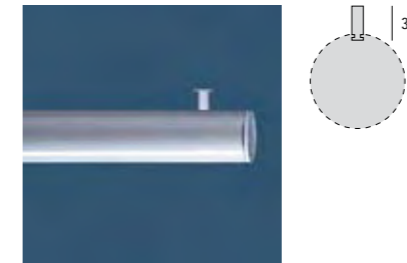

SILVER
SX 99-930-3

COUPLER

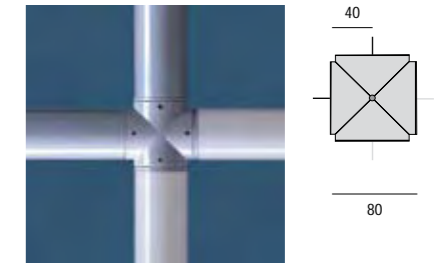

SILVER
SX 99-343-3 X Coupler
SX 99-341-3 L Coupler
SX 99-342-3 T Coupler

END CAP

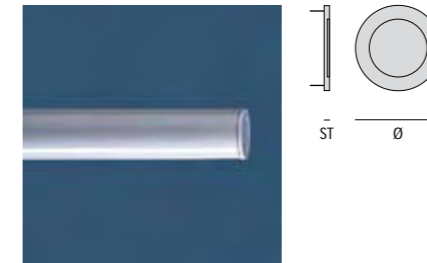

SILVER ST Ø
SX 63-000-0 4 60

ROTATING COUPLER

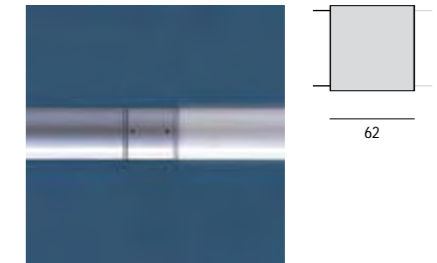

SILVER
SX 99-347-3 Rotating mid coupler
SX 99-357-3 Rotating end coupler

PENDANT ROD

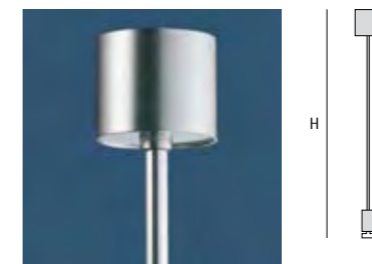

SILVER Ø H*
SX 99-820-3 10mm 600
SX 99-821-3 10mm 1200
SX 99-822-3 13mm 600
SX 99-823-3 13mm 1200

WIRE SUSPENSION

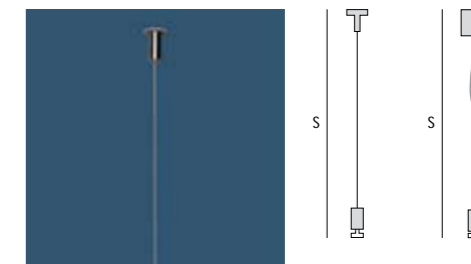

SILVER S*
SX 99-830-3 Wire suspension 1500
SX 99-831-3 3000
SX 99-824-3 with 3 core supply cable (3 x 0.75²) 1500
SX 99-825-3 3000
SX 99-826-3 with 5 core supply cable (5 x 1.5²) 1500
SX 99-827-3 3000

ST: Thickness · Ø: Diameter · H: Pendant rod length · S: Wire suspension length
 * can be cut on site