

DOWNLIGHTS ROUND DOUBLE FOCUS

- INSTALLATION AND REPLACEMENT OF LAMP FROM ABOVE CEILING AND/OR BELOW CEILING
- METAL HALIDE LAMPS COLOUR RENDERING IMPROVED
- CLEAR GLASS SHIELDING
- DOUBLE FOCUS REFLECTOR MADE OF ANODISED ALUMINIUM
- IMPROVED LAMP LIFE BY DUAL HEAT SINKS MADE OF HIGH QUALITY DIE-CAST ALUMINIUM
- ALUMINIUM DIE-CAST COMPLETION PLATE
- WHITE FINISH

DOWNLIGHT MOUNTING FROM BELOW

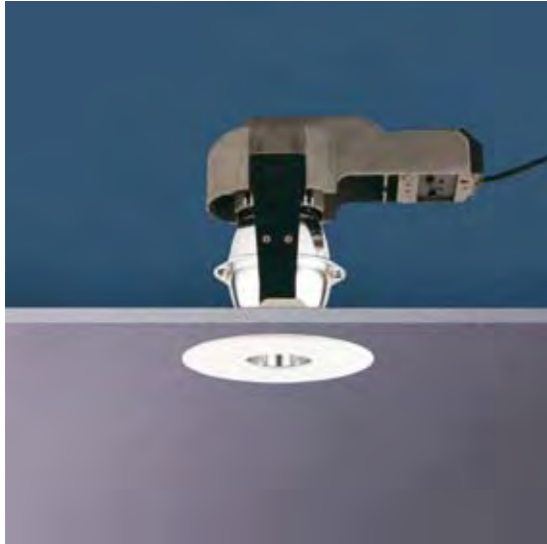

DOWNLIGHT MOUNTING FROM BELOW AND ABOVE



DOWNLIGHT MOUNTING FROM BELOW

		WHITE	B	C	ET	W	DATA
1 x 100W	QT12	SX 1031-01-1	143	122	185	1.0kg	5236

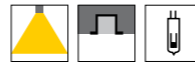

DOWNLIGHT MOUNTING FROM BELOW

		WHITE	B	C	ET	W	DATA
1 x 20W	HIT-TC-CE	SX 1036-01-1	143	122	185	1.0kg	5241
1 x 35W	HIT-TC-CE	SX 1037-01-1	143	122	185	1.0kg	5242

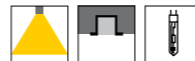

DOWNLIGHT MOUNTING FROM BELOW AND ABOVE - FOR CEILINGS TILT UP TO 25°

		WHITE	B	C	ET	W	DATA
1 x 35W	HIT-CE	SX 1308-01-1	230	205	290	2.2kg	5286
1 x 70W	HIT-CE	SX 1309-01-1	230	205	290	2.2kg	5287
1 x 150W	HIT-CE	SX 1310-01-1	230	205	290	2.2kg	5288

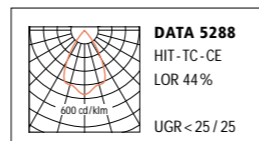
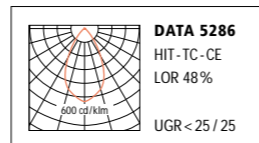
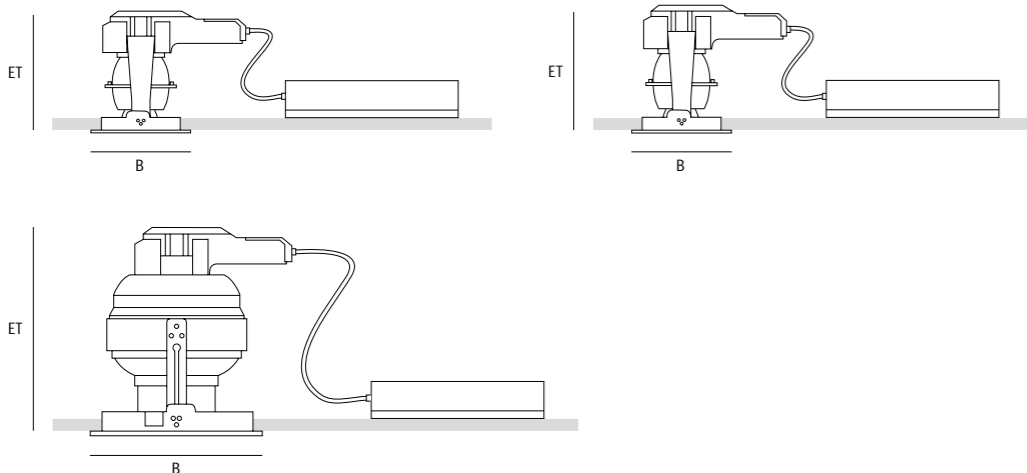
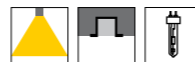

DOWNLIGHTS ROUND PENDANT AND SURFACE MOUNTED

- HIGH QUALITY BODY MADE OF ALUMINIUM CONTINUOUS CAST WITH ALUMINIUM DIE-CAST COMPLETION ELEMENT
- INTEGRAL ELECTRONIC TRANSFORMER FOR COMPACT FLUORESCENT LAMPS OR METAL HALIDE LAMPS
- REFLECTOR MADE OF ANODISED ALUMINIUM
- PENDANT VERSION ON REQUEST, DEPENDING ON PROJECT REQUIREMENTS
- SAFETY GLASS SHIELDING
- WHITE OR BLACK FINISH
- IP65

DOWNLIGHT IP65



DOWNLIGHT IP65

		WHITE	BLACK	B	H	W	DATA
1 x 18W	TC-TEL	SX 1074-01-1	SX 1074-01-2	180	300	5.0kg	5251
1 x 26W	TC-TEL	SX 1264-01-1	SX 1264-01-2	207	320	5.0kg	5268
1 x 32W	TC-TEL	SX 1265-01-1	SX 1265-01-2	207	320	5.0kg	5269



DOWNLIGHT IP65

		WHITE	BLACK	B	H	W	DATA
1 x 35W	HIT-CE	SX 1081-01-1	SX 1081-01-2	180	300	5.0kg	5258
1 x 70W	HIT-CE	SX 1082-01-1	SX 1082-01-2	180	300	5.0kg	5259
1 x 70W	HIT-CE	SX 1270-01-1	SX 1270-01-2	207	320	5.0kg	5272
1 x 100W	HIT-CE	SX 1271-01-1	SX 1271-01-2	207	320	5.0kg	5273

