

## SURVIVOR H70

- WALL OR CEILING MOUNTED LUMINAIRE
- DIRECT
- OPAL SAFETY GLASS DIFFUSER
- EMERGENCY ON REQUEST
- EXTRUDED ALUMINIUM BODY
- UPPER DUAL CABLEWAY
- VANDAL RESISTANT
- WHITE OR SILVER FINISH
- IP65

### SURVIVOR



### SURVIVOR

	WHITE	SILVER	L	B	H	M	W	DATA
1 x 36W	<b>SX 510 011 132</b>	<b>SX 510 013 132</b>	1290	240	70	1000	10.0kg	1585
2 x 36W	<b>SX 510 011 232</b>	<b>SX 510 013 232</b>	1290	240	70	1000	10.0kg	1586
1 x 58W	<b>SX 510 011 150</b>	<b>SX 510 013 150</b>	1590	240	70	1000	12.3kg	1585
2 x 58W	<b>SX 510 011 250</b>	<b>SX 510 013 250</b>	1590	240	70	1000	12.3kg	1586
1 x 28W	<b>SX 510 011 128</b>	<b>SX 510 013 128</b>	1240	240	70	1000	9.7kg	1587
2 x 28W	<b>SX 510 011 228</b>	<b>SX 510 013 228</b>	1240	240	70	1000	9.7kg	1588
1 x 35W	<b>SX 510 011 135</b>	<b>SX 510 013 135</b>	1540	240	70	1000	12.0kg	1587
2 x 35W	<b>SX 510 011 235</b>	<b>SX 510 013 235</b>	1540	240	70	1000	12.0kg	1588

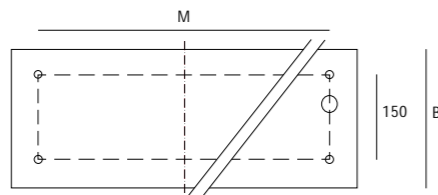
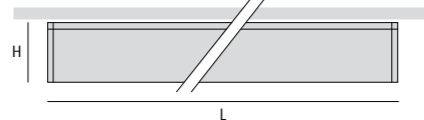
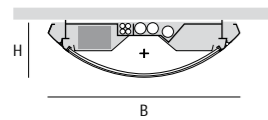

	<b>DATA 1585</b> T26 / T8 LOR 65% Φ <sub>u</sub> 99% UGR < 22 / 19
	<b>DATA 1586</b> T26 / T8 LOR 59% Φ <sub>u</sub> 99% UGR < 25 / 22
	<b>DATA 1587</b> T16 / T5 LOR 81% Φ <sub>u</sub> 98% UGR < 22 / 19
	<b>DATA 1588</b> T16 / T5 LOR 78% Φ <sub>u</sub> 99% UGR < 25 / 22



## SURVIVOR H70

- WALL OR CEILING MOUNTED LUMINAIRE
- DIRECT
- PRISMATIC DIFFUSER
- EMERGENCY ON REQUEST
- EXTRUDED ALUMINIUM BODY
- UPPER DUAL CABLEWAY
- VANDAL RESISTANT
- WHITE OR SILVER FINISH
- IP65

### SURVIVOR



### SURVIVOR

	WHITE	SILVER	L	B	H	M	W	DATA
1 x 36W	<b>SX 509 011 132</b>	<b>SX 509 013 132</b>	1290	240	70	1000	6.7kg	1591
2 x 36W	<b>SX 509 011 232</b>	<b>SX 509 013 232</b>	1290	240	70	1000	6.7kg	1592
1 x 58W	<b>SX 509 011 150</b>	<b>SX 509 013 150</b>	1590	240	70	1000	8.1kg	1591
2 x 58W	<b>SX 509 011 250</b>	<b>SX 509 013 250</b>	1590	240	70	1000	8.1kg	1592

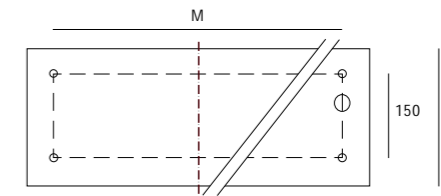
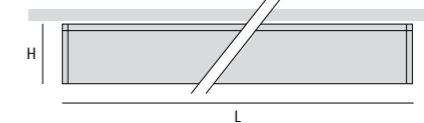
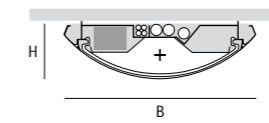

	<b>DATA 1591</b> T26 / T8 LOR 77% Φ <sub>u</sub> 97% UGR < 22 / 19
--	--

	<b>DATA 1592</b> T26 / T8 LOR 63% Φ <sub>u</sub> 97% UGR < 22 / 22
--	--

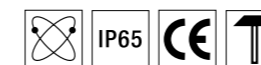

L: Length · B: Width · H: Height · M: Distance between fixation points · W: Weight



## SURVIVOR H70 ACCESSORIES

### MITRED CORNER HORIZONTAL

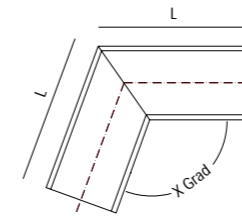

**SX 99-749-0** Extruded aluminium, angle and length to be specified

### MEDIA TRUNKING PROFILE

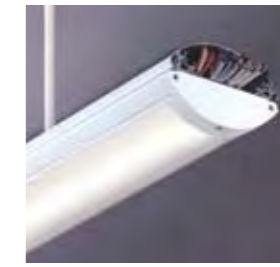

**SX 515 00.-\*** Ceiling mounted

### MITRED CORNER VERTICAL

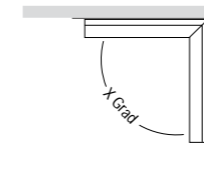

**SX 99-743-0** Extruded aluminium, angle to be specified

### MEDIA TRUNKING PROFILE

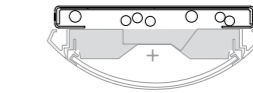

**SX 517 00.-\*** Ceiling mounted

### DUMMY PROFILE

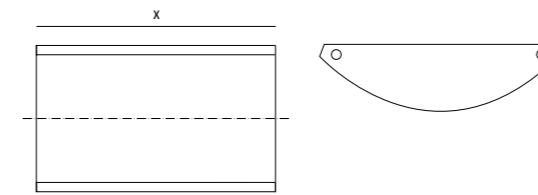

**SX 519 971 00** Extruded aluminium, length to be specified

**SX 99-744-1** End plate to complete luminaire

### MEDIA TRUNKING PROFILE

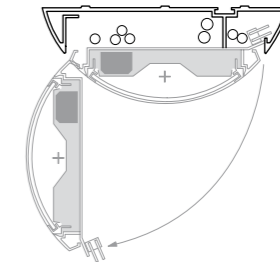

**SX 518 00.-\*** Ceiling mounted or pendant suspension

### BRACKET

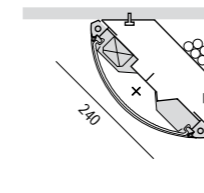

**SX 99-747-0** For corner mounting, cableway behind the luminaire

### END PLATE

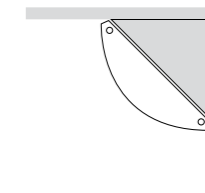

**SX 99-746-1** To complete corner mounting

### LOUDSPEAKER UNIT

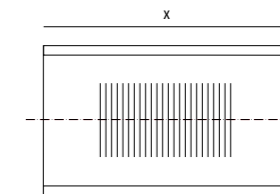

**SX 99-748-0** For loudspeakers 10 / 6 / 3W-100V / ELA, minimum length 400mm

Customer specifies suspension

\* End plates to complete media trunking profiles on request

## SURVIVOR H60

- WALL OR CEILING MOUNTED LUMINAIRE
- DIRECT
- PRISMATIC DIFFUSER
- EMERGENCY ON REQUEST
- EXTRUDED ALUMINIUM BODY
- UPPER DUAL CABLEWAY
- VANDAL RESISTANT
- WHITE FINISH
- IP65

### SURVIVOR



### SURVIVOR



### SURVIVOR

	WHITE	SILVER	L	B	H	M	W	DATA
1 x 28W	<b>SX 508 011 128</b>	<b>SX 508 013 128</b>	1350	240	60	1000	6.4 kg	1594
2 x 28W	<b>SX 508 011 228</b>	<b>SX 508 013 228</b>	1350	240	60	1000	6.4 kg	1595
1 x 35W	<b>SX 508 011 135</b>	<b>SX 508 013 135</b>	1650	240	60	1000	7.8 kg	1594
2 x 35W	<b>SX 508 011 235</b>	<b>SX 508 013 235</b>	1650	240	60	1000	7.8 kg	1595



### SURVIVOR

	WHITE	L	B	H	M	W	DATA
1 x 18W TC-L	<b>SX 505 031 118</b>	350	240	60	209	8.0 kg	1597

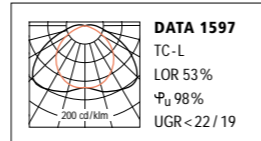
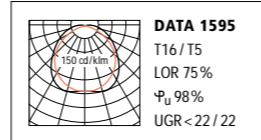
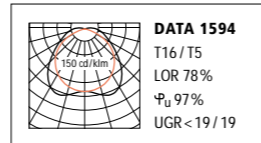
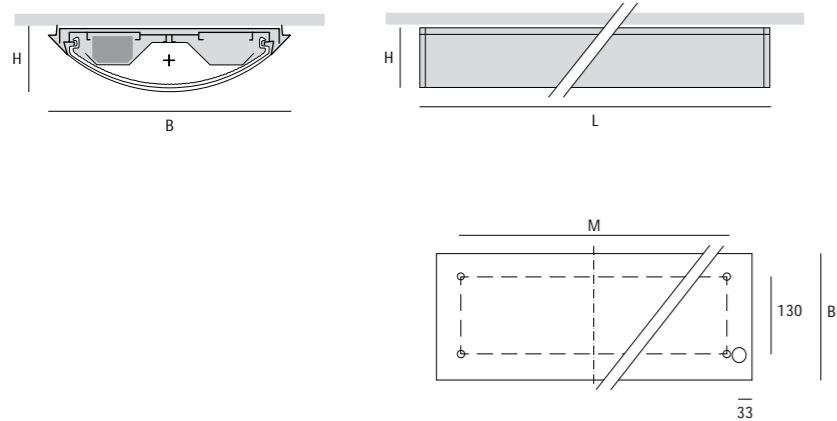

## SURVIVOR H60 ACCESSORIES

### MITRED CORNER HORIZONTAL

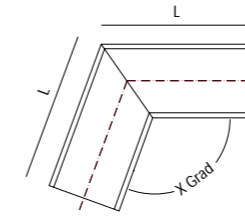

**SX 99-749-0** Extruded aluminium, angle and length to be specified

### MITRED CORNER VERTICAL

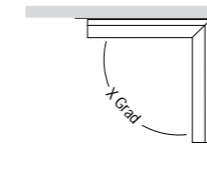

**SX 99-743-0** Extruded aluminium, angle to be specified

### MEDIA TRUNKING PROFILE

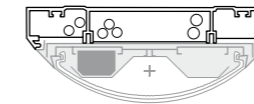

**SX 514 00.-\*** Pendant suspension

**SX 516 00.-\*** Ceiling mounted

**SX 513 00.-\*** Ceiling mounted or pendant suspension

Loudspeaker unit (minimum length 400mm) on request

Customer specifies suspension

\* End plates to complete media trunking profiles on request