



Spider LED è un apparecchio d'illuminazione per esterni da parete o plafone, particolarmente adatto per un uso architettuale su facciate, davanzali, vetrine etc.

Spider LED è disponibile in tre misure da 14 a 28 LED nelle tonalità bianco caldo 3000K o bianco naturale 4000K.

La struttura è in estruso di alluminio anodizzato con testate di chiusura in alluminio pressofuso e con vetro temperato sabbiato, grado di protezione IP65. Alimentatore a 350 mA fornito di serie nell'apparecchio.

Outdoor lighting fitting for wall or ceiling use particularly indicated for facades, windows, and ledges etc.

Spider LED is available in three measures from 14 to 28 LED, warm 3000K or natural 4000K white.

Extruded aluminum structure with die-cast aluminum and caps, tempered opal glass, IP65.

Driver 350 mA included in the fittings.

Luminaire d'extérieur pour l'installation au mur ou au plafond, particulièrement indiqué pour façades, fenêtres et corniches.

Spider LED est disponible en trois mesures de 14 à 28 LED, en teinte blanc chaud 3000K ou naturelle blanche 4000K.

Structure en aluminium extrudé avec embouts de fermeture en fonte d'aluminium, verre trempé opale. IP65.

350 mA Driver 350 mA inclus.



CE IP65

05

JAC.140157

14 LEDx1,2W

Versione da 660 mm con LED tono bianco naturale 4000K.
 Driver 350 mA incluso.
 Version 660 mm with LED natural white 4000K.
 Driver 350 mA included.
 Modèle de 660 mm avec LED blanc naturel 4000K. Driver 350 mA inclus.

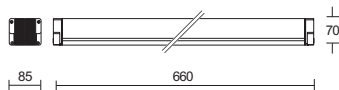

JAC.140158

14 LEDx1,2W

Versione da 660 mm con LED tono bianco caldo 3000K.
 Driver 350 mA incluso.
 Version 660 mm with LED warm white 3000K.
 Driver 350 mA included.
 Modèle de 660 mm avec LED blanc chaud 3000K.
 Driver 350 mA inclus.

*Gli attacchi a parete e a plafone sono forniti come accessori, su richiesta.
 Wall and ceiling mounts are available as accessories, on request.
 Fixations mural et plafond sont à commander séparément, comme accessoires.*

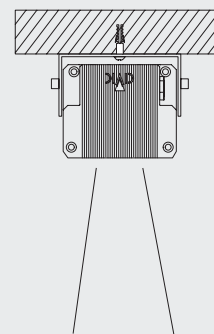
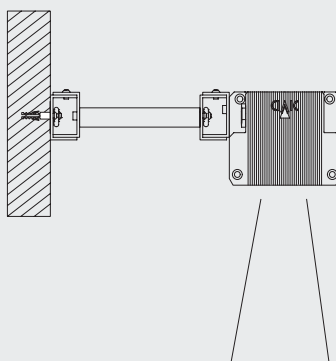
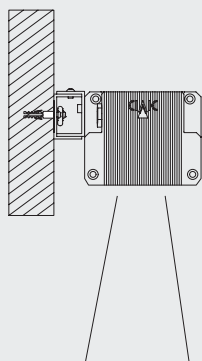

CE IP65

05

JAC.210157

21 LEDx1,2W

Versione da 960 mm con LED tono bianco naturale 4000K.
Driver 350 mA incluso.
Version 960 mm with LED natural white 4000K.
Driver 350 mA included.
Modèle de 960 mm avec LED blanc naturel 4000K.
Driver 350 mA inclus.

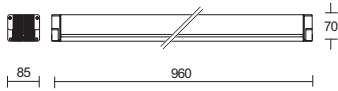

JAC.210158

21 LEDx1,2W

Versione da 960 mm con LED tono bianco caldo 3000K.
Driver 350 mA incluso.
Version 960 mm with LED warm white 3000K.
Driver 350 mA included.
Modèle de 960 mm avec LED blanc chaud 3000K.
Driver 350 mA inclus.

*Gli attacchi a parete e a plafone sono forniti come accessori, su richiesta.
Wall and ceiling mounts are available as accessories, on request.
Fixations mural et plafond sont à commander séparément, comme accessoires.*

CE IP65

05

JAC.280157

28 LEDx1,2W

Versione da 1260 mm con LED tono bianco naturale 4000K.
Driver 350 mA incluso.
Version 1260 mm with LED natural white 4000K.
Driver 350 mA included.
Modèle de 1260 mm avec LED blanc naturel 4000K.
Driver 350 mA inclus.

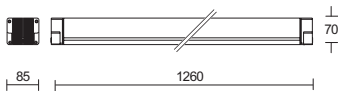

JAC.280158

28 LEDx1,2W

Versione da 1260 mm con LED tono bianco caldo 3000K.
Driver 350 mA incluso.
Version 1260 mm with LED warm white 3000K.
Driver 350 mA included.
Modèle de 1260 mm avec LED blanc chaud 3000K.
Driver 350 mA inclus.

*Gli attacchi a parete e a plafone sono forniti come accessori, su richiesta.
Wall and ceiling mounts are available as accessories, on request.
Fixations mural et plafond sont à commander séparément, comme accessoires.*

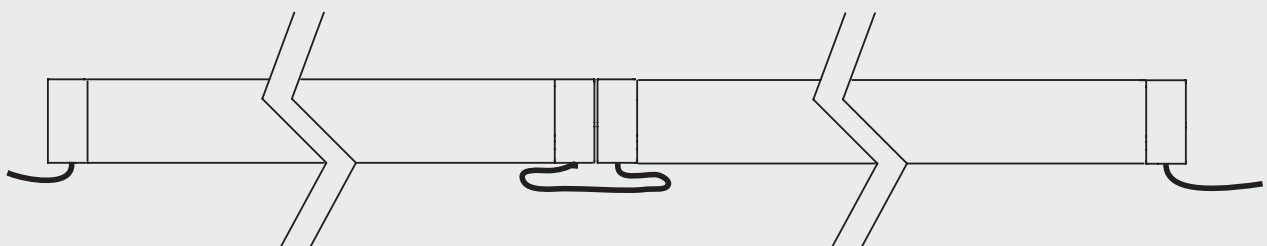
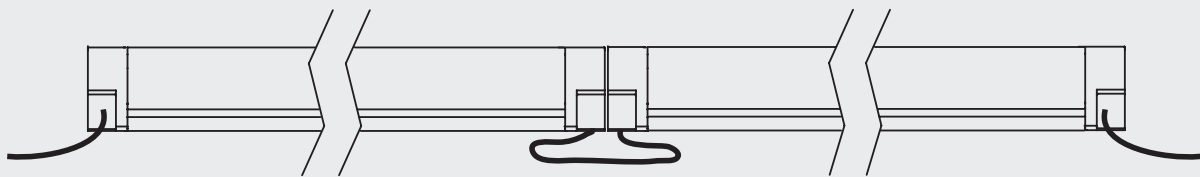

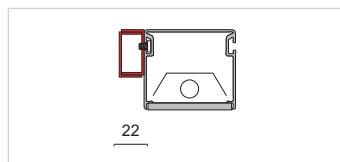

JAC.AP ○ 05

Attacco a parete.
Wall mount.
Fixation murale.

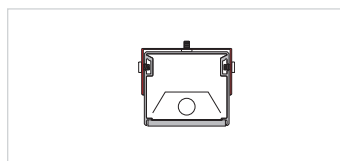

JAC.DP ○ 05

Attacco a plafone (coppia).
Ceiling mount (pair).
Fixation plafond (couple).

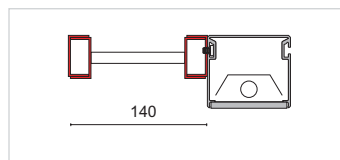

JAC.BP ○ 05

Braccio parete.
Wall bracket.
Fixation murale.



JAC.PC

Pressacavo IP65.
Cable gland IP65.
Presse étoupe IP65.