



DL 4051 Visual

Lampada alogenuri metallici
Metal halide lamp

	599.4051.1.71.00.1	HIE-CE	E27	1 x 70 W BI/WH
	599.4051.1.71.00.2	HIE-CE	E27	1 x 70 W NE/BK
	599.4051.1.71.00.3	HIE-CE	E27	1 x 70 W GI/GR
	599.4051.1.71.00.4	HIE-CE	E27	1 x 70 W AN/AN
	599.4051.1.71.00.0	HIE-CE	E27	1 x 70 W AR/SI

DL 4051 Visual

Lampada sodio alta pressione
High pressure sodium lamp

	599.4051.1.59.00.1	HSE-I	E27	1 x 70 W BI/WH
	599.4051.1.59.00.2	HSE-I	E27	1 x 70 W NE/BK
	599.4051.1.59.00.3	HSE-I	E27	1 x 70 W GI/GR
	599.4051.1.59.00.4	HSE-I	E27	1 x 70 W AN/AN
	599.4051.1.59.00.0	HSE-I	E27	1 x 70 W AR/SI

DL 4051 Visual

Lampada a vapori di mercurio
Mercury vapour lamp

	599.4051.1.55.00.1	HME	E27	1 x 80 W BI/WH
	599.4051.1.55.00.2	HME	E27	1 x 80 W NE/BK
	599.4051.1.55.00.3	HME	E27	1 x 80 W GI/GR
	599.4051.1.55.00.4	HME	E27	1 x 80 W AN/AN
	599.4051.1.55.00.0	HME	E27	1 x 80 W AR/SI

DL 4051 Visual

Lampada fluorescente compatta
Compact fluorescent lamp

	599.4051.1.46.00.1	TC-D	G24-d3	1 x 26 W BI/WH
	599.4051.1.46.00.2	TC-D	G24-d3	1 x 26 W NE/BK
	599.4051.1.46.00.3	TC-D	G24-d3	1 x 26 W GI/GR
	599.4051.1.46.00.4	TC-D	G24-d3	1 x 26 W AN/AN
	599.4051.1.46.00.0	TC-D	G24-d3	1 x 26 W AR/SI

DL 4051 Visual

Lampada fluorescente compatta
Compact fluorescent lamp

	599.4051.1.52.00.1	TC-TEL	GX24-q4	1 x 42 W BI/WH
	599.4051.1.52.00.2	TC-TEL	GX24-q4	1 x 42 W NE/BK
	599.4051.1.52.00.3	TC-TEL	GX24-q4	1 x 42 W GI/GR
	599.4051.1.52.00.4	TC-TEL	GX24-q4	1 x 42 W AN/AN
	599.4051.1.52.00.0	TC-TEL	GX24-q4	1 x 42 W AR/SI

DL 4051 Visual

Lampada fluorescente compatta elettronica
Electronic fluorescent lamp

	599.4051.1.54.00.1	TC-TSE	E27	1 x 23 W BI/WH
	599.4051.1.54.00.2	TC-TSE	E27	1 x 23 W NE/BK
	599.4051.1.54.00.3	TC-TSE	E27	1 x 23 W GI/GR
	599.4051.1.54.00.4	TC-TSE	E27	1 x 23 W AN/AN
	599.4051.1.54.00.0	TC-TSE	E27	1 x 23 W AR/SI

DL 4051 Visual

Lampada alogena
Halogen Lamp

	599.4051.1.24.00.1	QT32	E27	1 x 100 W BI/WH
	599.4051.1.24.00.2	QT32	E27	1 x 100 W NE/BK
	599.4051.1.24.00.3	QT32	E27	1 x 100 W GI/GR
	599.4051.1.24.00.4	QT32	E27	1 x 100 W AN/AN
	599.4051.1.24.00.0	QT32	E27	1 x 100 W AR/SI

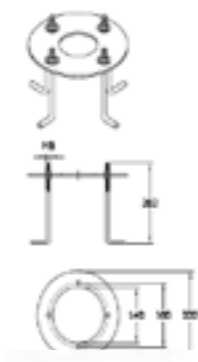
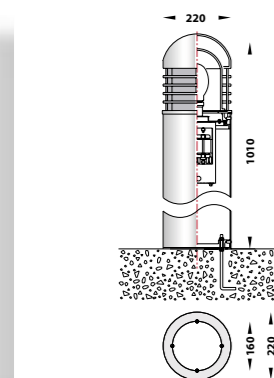
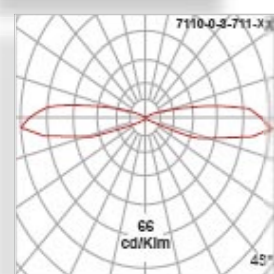
599.9031.A.00.00.Z
Base di ancoraggio
Anchor bolt kit

HE-CE E27 70W

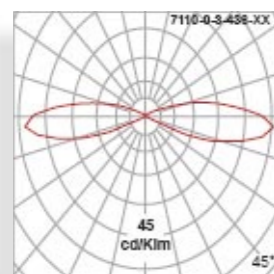

TC-TEL GX24q-4 42W

CORPO IN ALLUMINIO ESTRUSO S6063
COPERCHI E BASE DI FISSAGGIO IN PRESSOFUSIONE DI ALLUMINIO ADC12 VERNICIATO A POLVERE CON PRETRATTAMENTO SPECIALE PER ESTERNI
DIFFUSORE IN POLICARBONATO AUTOESTINGUENTE STABILIZZATO UV
SELF-EXTINGUISHING IMPACT RESISTANT POLYCARBONATE DIFFUSER WITH UV STABILIZED ADDITIVE
VITERIA IN ACCIAIO INOX
GUARNIZIONI IN GOMMA SILICONICA. TEMPERATURA DI SERVIZIO -40° +250°C

BODY IN CORROSION RESISTANT EXTRUSION ALUMINIUM S6063
COVERS AND WALL BRACKET IN HIGH-PRESSURE DIE-CAST ALUMINIUM ADC12 ALLOY POWDER COATED WITH PRETREATMENT FOR OUTDOOR USE
STAINLESS STEEL SCREWS
WEATHER PROOF AND DURABLE SILICONE GASKET. SERVICE TEMPERATURE -40° +250°C

DL 4052 Visual

Lampada alogenuri metallici
Metal halide lamp

	599.4052.1.71.00.1	HIE-CE	E27	1 x 70 W BI/WH
	599.4052.1.71.00.2	HIE-CE	E27	1 x 70 W NE/BK
	599.4052.1.71.00.3	HIE-CE	E27	1 x 70 W GI/GR
	599.4052.1.71.00.4	HIE-CE	E27	1 x 70 W AN/AN
	599.4052.1.71.00.0	HIE-CE	E27	1 x 70 W AR/SI

DL 4052 Visual

Lampada sodio alta pressione
High pressure sodium lamp

	599.4052.1.59.00.1	HSE-I	E27	1 x 70 W BI/WH
	599.4052.1.59.00.2	HSE-I	E27	1 x 70 W NE/BK
	599.4052.1.59.00.3	HSE-I	E27	1 x 70 W GI/GR
	599.4052.1.59.00.4	HSE-I	E27	1 x 70 W AN/AN
	599.4052.1.59.00.0	HSE-I	E27	1 x 70 W AR/SI

DL 4052 Visual

Lampada a vapori di mercurio
Mercury vapour lamp

	599.4052.1.55.00.1	HME	E27	1 x 80 W BI/WH
	599.4052.1.55.00.2	HME	E27	1 x 80 W NE/BK
	599.4052.1.55.00.3	HME	E27	1 x 80 W GI/GR
	599.4052.1.55.00.4	HME	E27	1 x 80 W AN/AN
	599.4052.1.55.00.0	HME	E27	1 x 80 W AR/SI

DL 4052 Visual

Lampada fluorescente compatta
Compact fluorescent lamp

	599.4052.1.46.00.1	TC-D	G24-d3	1 x 26 W BI/WH
	599.4052.1.46.00.2	TC-D	G24-d3	1 x 26 W NE/BK
	599.4052.1.46.00.3	TC-D	G24-d3	1 x 26 W GI/GR
	599.4052.1.46.00.4	TC-D	G24-d3	1 x 26 W AN/AN
	599.4052.1.46.00.0	TC-D	G24-d3	1 x 26 W AR/SI

DL 4052 Visual

Lampada fluorescente compatta
Compact fluorescent lamp

	599.4052.1.52.00.1	TC-TEL	GX24-q4	1 x 42 W BI/WH
	599.4052.1.52.00.2	TC-TEL	GX24-q4	1 x 42 W NE/BK
	599.4052.1.52.00.3	TC-TEL	GX24-q4	1 x 42 W GI/GR
	599.4052.1.52.00.4	TC-TEL	GX24-q4	1 x 42 W AN/AN
	599.4052.1.52.00.0	TC-TEL	GX24-q4	1 x 42 W AR/SI

DL 4052 Visual

Lampada fluorescente compatta elettronica
Electronic fluorescent lamp

	599.4052.1.54.00.1	TC-TSE	E27	1 x 23 W BI/WH
	599.4052.1.54.00.2	TC-TSE	E27	1 x 23 W NE/BK
	599.4052.1.54.00.3	TC-TSE	E27	1 x 23 W GI/GR
	599.4052.1.54.00.4	TC-TSE	E27	1 x 23 W AN/AN
	599.4052.1.54.00.0	TC-TSE	E27	1 x 23 W AR/SI

DL 4052 Visual

Lampada alogena
Halogen Lamp

	599.4052.1.24.00.1	QT32	E27	1 x 100 W BI/WH
	599.4052.1.24.00.2	QT32	E27	1 x 100 W NE/BK
	599.4052.1.24.00.3	QT32	E27	1 x 100 W GI/GR
	599.4052.1.24.00.4	QT32	E27	1 x 100 W AN/AN
	599.4052.1.24.00.0	QT32	E27	1 x 100 W AR/SI

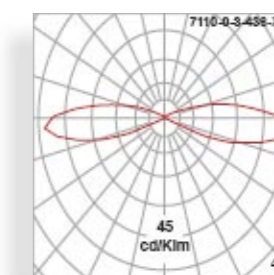

TC-TEL GX24q-4 42W

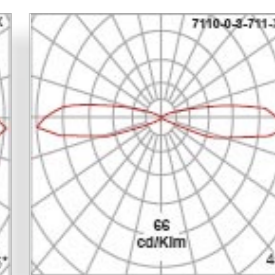

HE-CE E27 70W

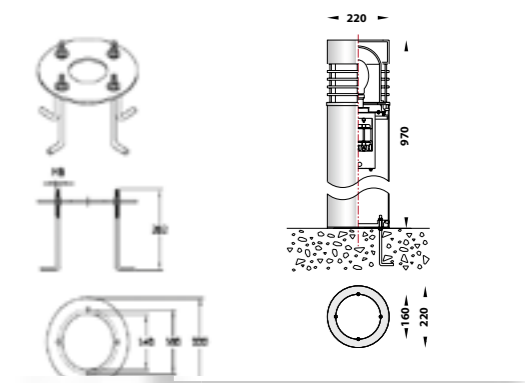
599.9031.A.00.00.Z
Base di ancoraggio
Anchor bolt kit

CORPO IN ALLUMINIO ESTRUSO S6063
COPERCHI E BASE DI FISSAGGIO IN PRESSOFUSIONE DI ALLUMINIO ADC12 VERNICIATO A POLVERE CON PRETRATTAMENTO SPECIALE PER ESTERNI
DIFFUSORE IN POLICARBONATO AUTOESTINGUENTE STABILIZZATO UV
SELF-EXTINGUISHING IMPACT RESISTANT POLYCARBONATE DIFFUSER WITH UV STABILIZED ADDITIVE
VITERIA IN ACCIAIO INOX
GUARNIZIONI IN GOMMA SILICONICA. TEMPERATURA DI SERVIZIO -40° +250°C

BODY IN CORROSION RESISTANT EXTRUSION ALUMINIUM S6063
COVERS AND WALL BRACKET IN HIGH-PRESSURE DIE-CAST ALUMINIUM ADC12 ALLOY POWDER COATED WITH PRETREATMENT FOR OUTDOOR USE
STAINLESS STEEL SCREWS
WEATHER PROOF AND DURABLE SILICONE GASKET. SERVICE TEMPERATURE -40° +250°C

