

serie/series

# Urano mini



example code:  

art.	electrification	finishing	size
9440	F18	.	PA6B

art.  
**9440**

design **Ufficio Tecnico Landa**

corpo **acciaio inox AISI 316L**  
 body **stainless steel AISI 316L**  
 corps **acier inoxydable AISI 316L**  
 cuerpo **acero inox AISI 316L**  
 Körper **Edelstahl AISI 316L**

code 9440...

960°



diffusore **policarbonato trasparente**  
 diffuser **transparent polycarbonate**  
 difusor **policarbonato transparente**  
 Diffuser **Polykarbonat klar**

code 9440...**B**

850°



diffusore **policarbonato opale**  
 diffuser **opal polycarbonate**  
 difusor **policarbonato opalo**  
 Diffuser **Polykarbonat opal**

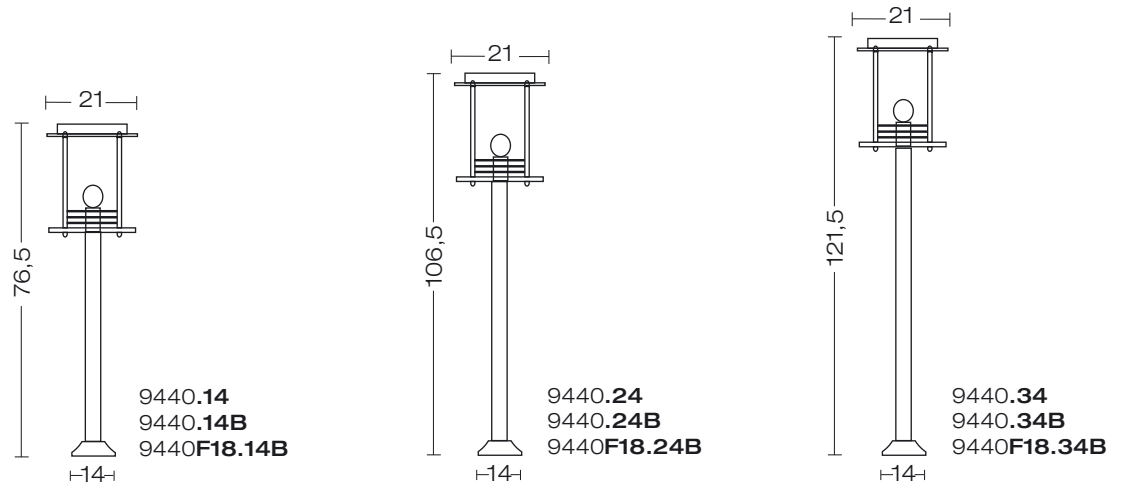
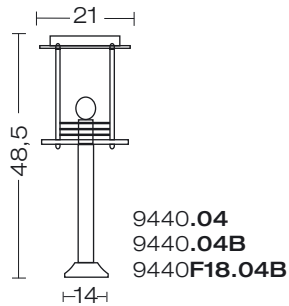
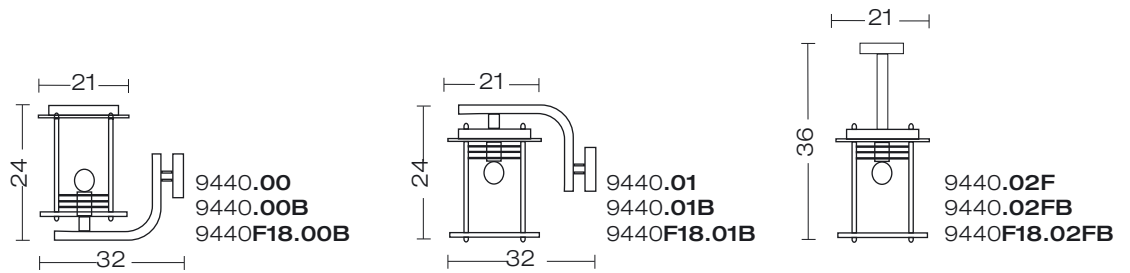

For technical details visit  
[www.landa.it](http://www.landa.it)

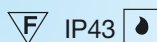

ELECTRIFICATION

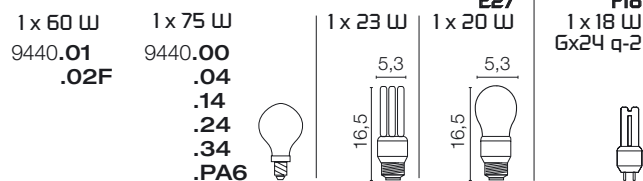

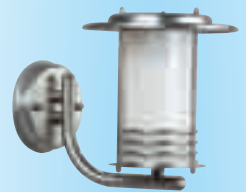

code 00DEC

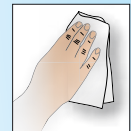

pulisci acciaio  
stainless steel cleaner  
kit nettoyage inox  
abrilantador inox  
Edelstahlreiniger  
details: **page 267**